

Caltalina Gazebo

Item#: L-GZ660PST
TV. #:187020

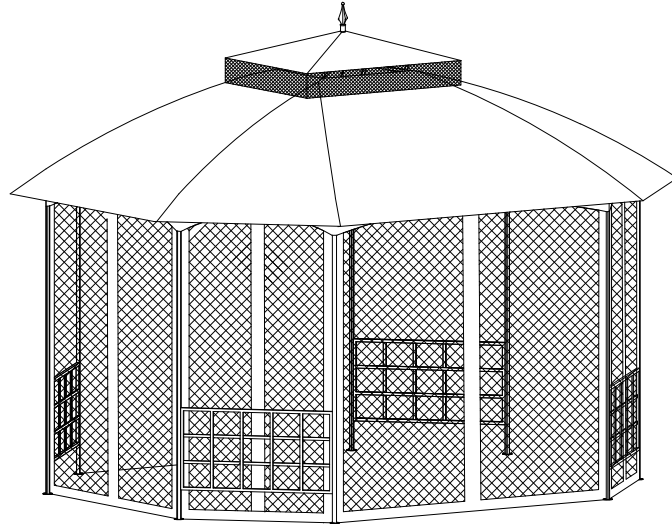

IMPORTANT:

KEEP THIS INSTRUCTION MANUAL FOR FUTURE REFERENCE.











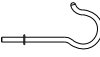

WARNING:

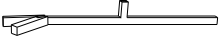
1. Two people are required for assembly.
2. Some parts may contain sharp edges. We recommend that you wear protective gloves.
3. When assembling and using this product, basic safety precautions should always be followed to reduce the risk of personal injury or damage. Please read all instructions before assembly and usage.
4. Do not leave the gazebo up where there is a risk of high winds, as possible damage will occur to the structure. The manufacturer or retailer is not liable for any loss of the product or other items due to the failure to take down the gazebo during strong wind.
5. **WARNING:** Keep all flame and heat sources away from this gazebo fabric. This gazebo is made with fabric that meets CPAI-84 specifications for flame resistance. It is not fire proof. The fabric will burn if left in continuous contact with any flame source. The application of any foreign substance to the gazebo fabric may render the flame-resistant properties ineffective.

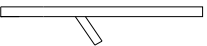
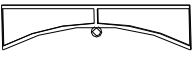

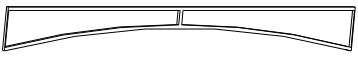
PREPARATION:

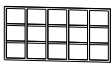
Before beginning assembly of this product, make sure all parts are present. Compare parts with package contents list. If any part is missing or damaged, do not attempt to assemble the product.

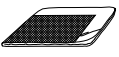
Parts List

Description	Part NO#	Qty	Image
Top connector 1	A1	1	
Top connector 2	A	1	
Finial	B1	1	
Hook	B	1	
Side top connector 1	C3	4	
Side top connector 2	C4	4	
Long side pole 1	D1	4	
Short side pole 2	E2	4	
Corner connector	E3	8	
Arch bar 1	F	4	
Arch bar 2	G	2	
Arch bar 3	H	2	
Pole 1	I	4	
Pole 2	J	4	
Screen	K	4	
Small canopy	L	1	
Large canopy	M	1	
Mosquito netting	N	1	

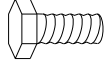
Hardware Pack 1

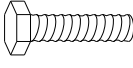
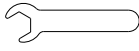
Part NO#	Description	Qty	Image
AA	M5*15 Bolt	32 PCS	
BB	M5 Washer	48 PCS	
CC	M5*35 Bolt	16 PCS	
W	M5 Wrench	1 PCS	

Step. 1

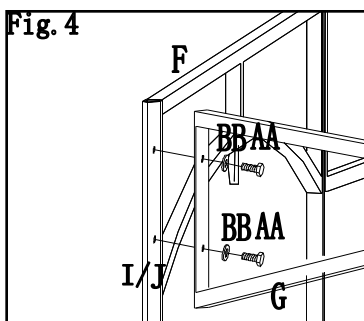
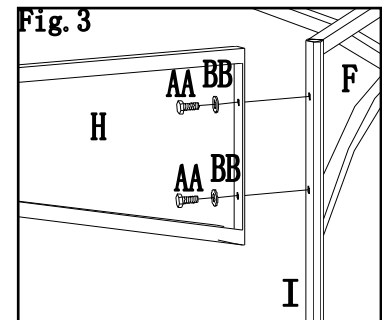
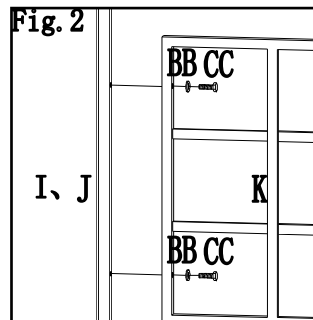
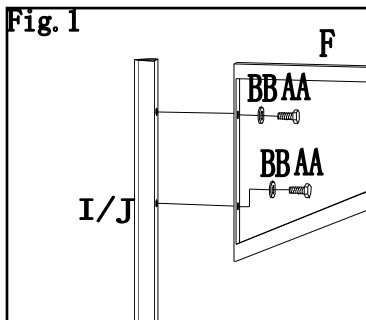
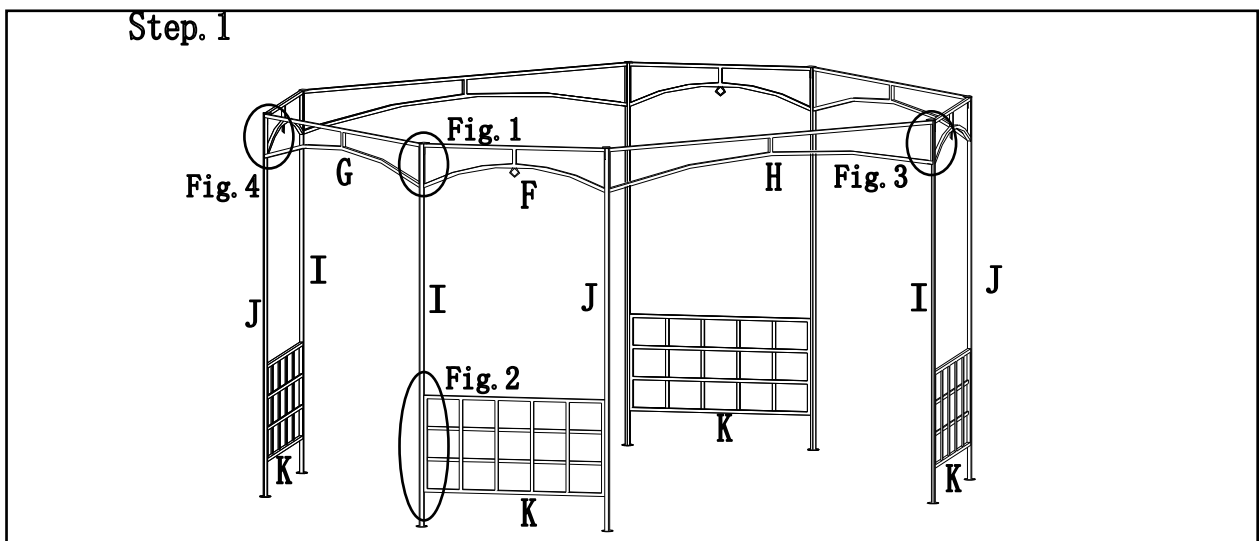

Fig.1: Using bolt (AA) and flat washer (BB) to assemble the beam 1(F) to the post 1 (I) or post 2 (J)

Fig.2: Using bolt (CC) and flat washer (BB) to connect the screen (K) to the post 1(I) or post 2 (J).

Fig.3: Using bolt (AA) and flat washer (BB) to connect the beam 3 (H) to the post 1 (I) or post 2 (J).

Fig.4: Using bolt (AA) and flat washer (BB) to connect beam 2 (G) to the post 1 (I) or post 2 (J). Secure all bolts by using wrench (W).

Hardware Pack 2

DD

Φ6*180 Peg

16 PCS



Step. 2

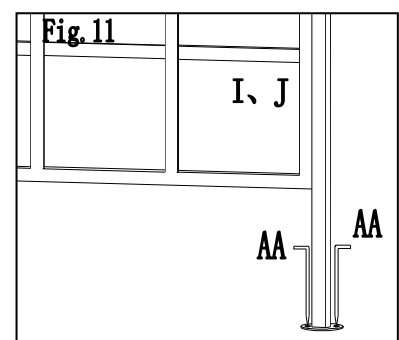
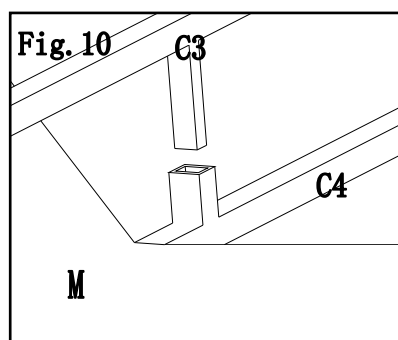
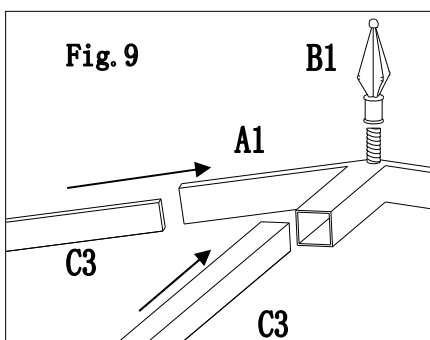
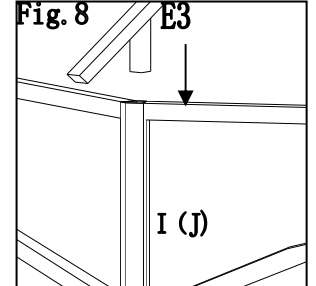
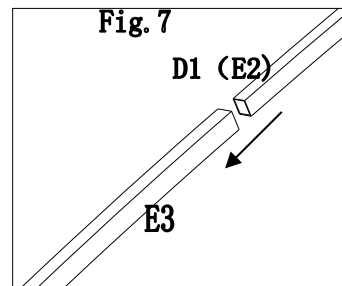
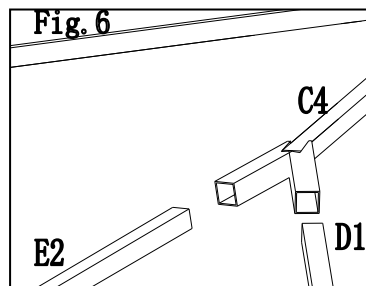
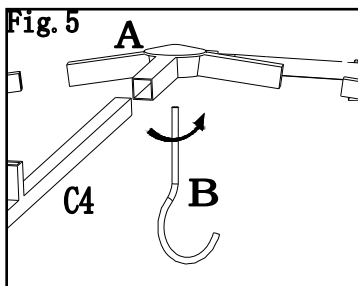
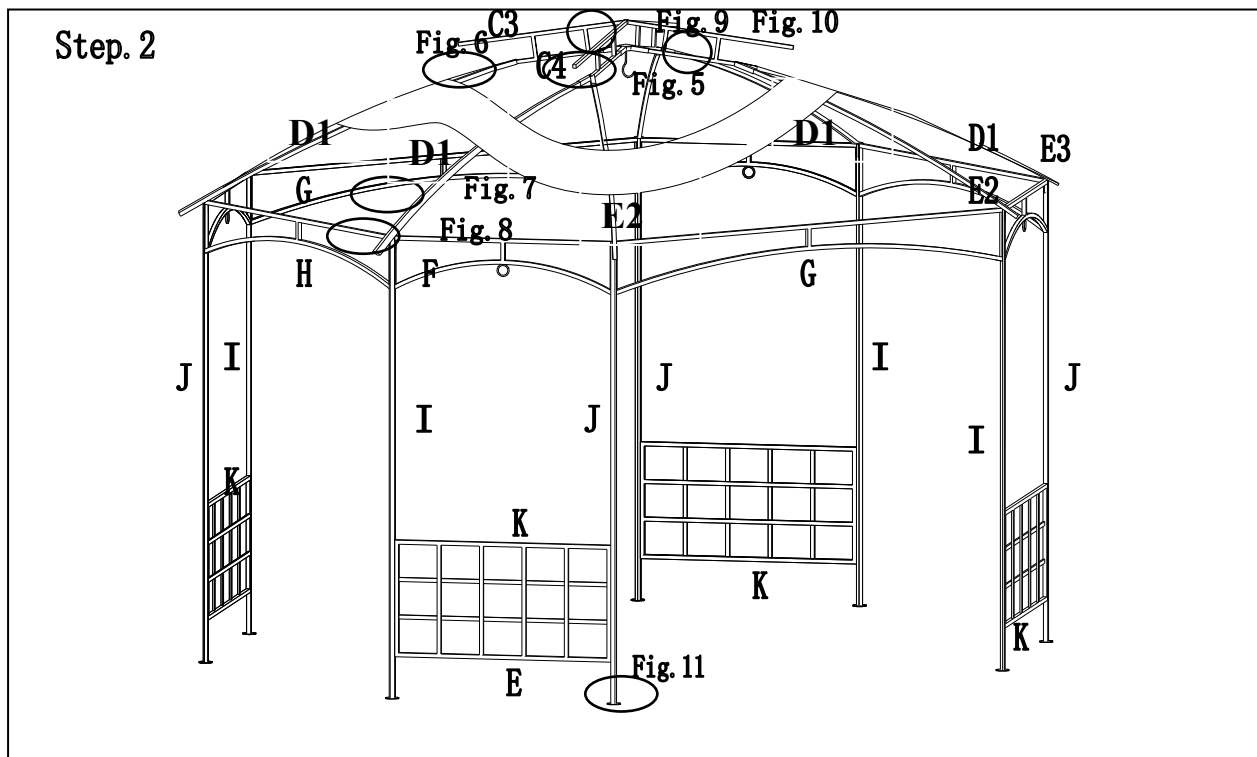

Fig.5: Insert Side top connector 2 (C4) to top connector 1 (A) and attach Hook (B) to top connector 2 (A).

Fig.6: Insert Side pole 1 (D1) and Side pole 2 (E2) into Side top connector 2 (C4).

Fig.7: Insert assembly Side pole 2 (E2) and Side pole 1 (D1) into Corner connector (E3).

Fig.8: Insert Corner connector (E3) to the other end of Pole 1 (I) & Pole 2 (J). Cover Large canopy (M) to the Big top. (Note: The bigger corner of big top connector (A) should point to the larger arch bar 3(H)).

Fig.9: Insert Side top connector 1 (C3) into Small top connector (A1), cover Small canopy (L) to the small top. Then attach Finial (B1) to top connector 1 (A1).

Fig.10: Insert the connect tube of Side top connector 1 onto Side top connector 2 (C4) and then Spread out Large canopy (M).

Fig.11: Fix the gazebo by Φ6*180 Peg (DD).

Hardware Pack 3

FF	Plastic tie	60 PCS	
----	-------------	--------	---

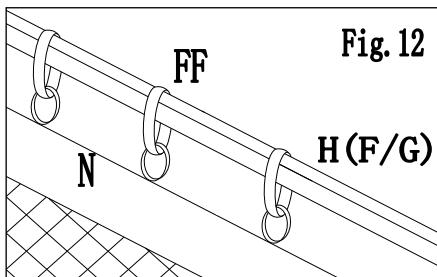
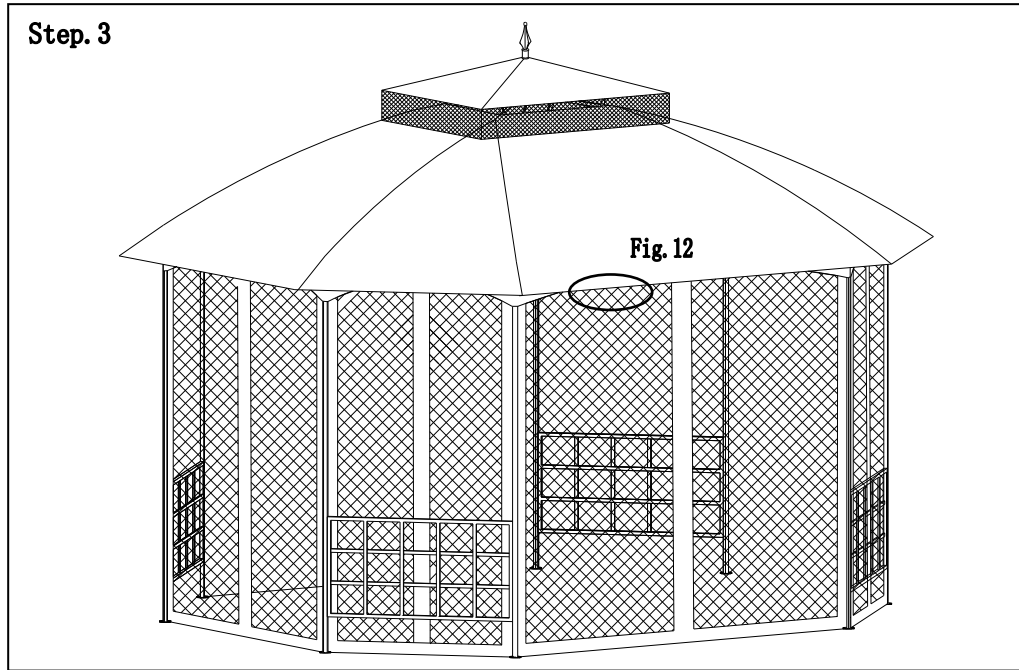

Fig.12: Hanging the mosquito netting (N) to arch bar H (F/ G) by plastic tie (FF).

1 YEAR LIMITED WARRANTY

This product is warranted for 1 year against any defects in material and workmanship. If defective, the product will be repaired or replaced free of charge. Simply provide proof of purchase and return the product to your place of purchase. Normal wear or damage due to abuse, mishandling, or unauthorized repairs is not covered. The warranty gives you specific legal rights and you may have other rights which vary from state to state.

For customer service, please call 1(866)578-6569, hours of Operation: Monday-Friday 8:30 am to 8:30 pm EST or email customer service email address customer.care@sunjoygroup.com

Manufactured for and distributed
by True Value® Company
Chicago, IL 60631-3505
© 2019 True Value Company

Gazebo De Caltalina

Artículo#: L-GZ660PST

TV. #:187020

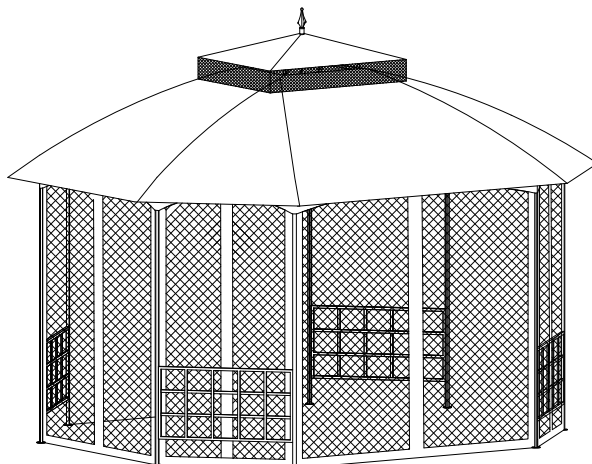

IMPORTANTE:

GUARDE ESTE MANUAL DE INSTRUCCIONES PARA CONSULTARLO CUANDO SEA NECESARIO.













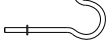

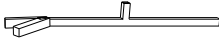
AVISO:

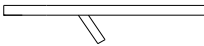
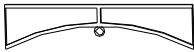
1. Se necesitan dos personas para el montaje.
2. Algunas piezas pueden tener bordes afilados. Le recomendamos el uso de guantes de protección.
3. Mientras este montando y utilizando este producto, tendrá que seguir siempre precauciones fundamentales de seguridad para reducir el riesgo de daños personales o al producto. Por favor, léase todas las instrucciones antes de montar y emplear.
4. No deje el gazebo montado cuando existe el riesgo de vientos Fuertes, porque se podrían producir daños a la estructura. El fabricante y el vendedor no se hacen responsables por ningún daño al producto o a otros artículos por la falta de desmontar el gazebo cuando hay viento fuerte.
5. **AVISO:** Mantenga todas llamas y Fuentes de calor lejos de la tela de esta Glorieta. Esta Glorieta está hecha con una tela que cumple con las especificaciones de resistencia a las llamas de CPAI-84. No es ignífuga. La tela prendera fuego si se deja en contacto continuo con cualquier llama. La aplicación de sustancias ajenas a la tela de la Glorieta pueden causar que las propiedades de resistencia a llamas sean ineficaces

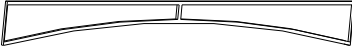

REPARACION:

Antes de empezar a montar este producto, asegúrese que todas las piezas están adjuntas. Compare las piezas con las listas de contenido de embalaje y de ferretería incluidas. Si falta alguna pieza o si alguna está dañada, no trate de montar el producto.

Lista de Piezas

Descripción	Pieza	Cantidad	Diagrama de la pieza
Conexión del techo 1	A1	1	
Conexión del techo 2	A	1	
Finial	B1	1	
Gancho central	B	1	
Conexión 1	C3	4	
Conexión 2	C4	4	
Poste barra 1	D1	4	
Poste barra 2	E2	4	
Conexión de esquina	E3	8	
Fachada 1	F	4	
Fachada 2	G	2	
Fachada 3	H	2	
Poste 1	I	4	
Poste 2	J	4	
Barrera	K	4	
Techo pequeño	L	1	
Techo grande	M	1	
Mosquiteros	N	1	

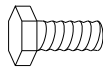
Lista de piezas de ferretería 1

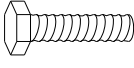
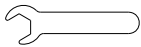
Pieza	Descripción	Cantidad	Diagrama de la pieza
AA	M5*15 Tornillo	32 PCS	
BB	M5 Arandela plana	48 PCS	
CC	M5*35 Tornillo	16 PCS	
W	M5 Llave	1 PCS	

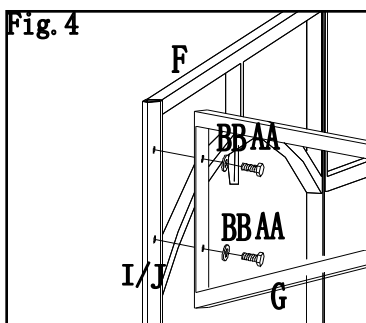
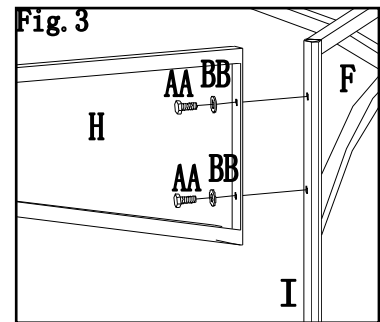
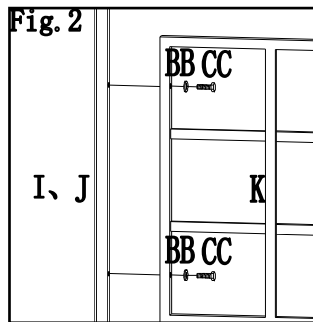
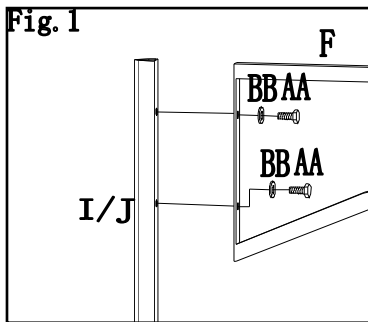
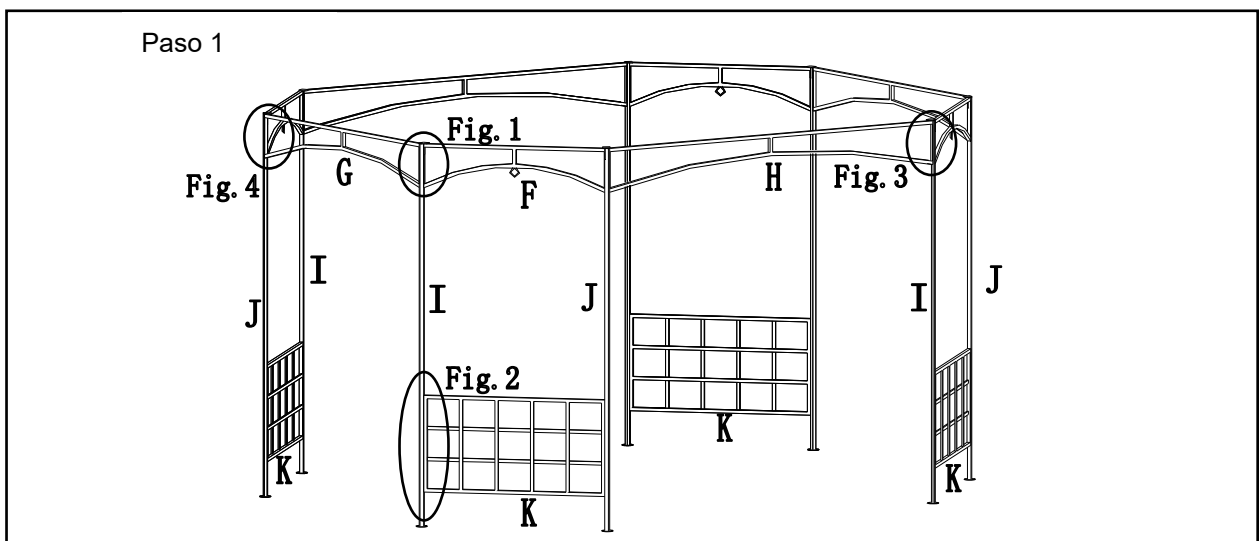

- Fig.1: Utilice tornillo (AA), arandela plana (BB) para conectar el fachada 1 (F) a la poste 1 /2 (I/J).
- Fig.2: Utilice tornillo (CC), arandela plana (BB) para conectar el barrera (K) a la poste 1 /2 (I/J).
- Fig.3: Utilice tornillo (AA), arandela plana (BB) para conectar el fachada 3 (H) a la poste 1 /2 (I/J).
- Fig.4: Utilice tornillo (AA), arandela plana (BB) para conectar el fachada 2 (G) a la poste 1 /2 (I/J). Después de las etapas anteriores, utilice una llave (W) para apretar todos los tornillos, pero no los apriete demasiado.

Lista de piezas de ferretería 2

DD	Φ6*180 Estaca	16 PCS	
----	---------------	--------	---

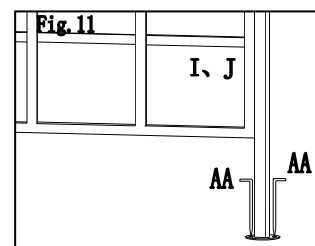
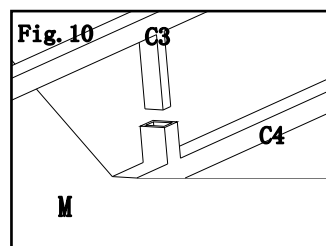
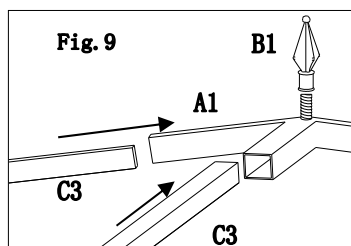
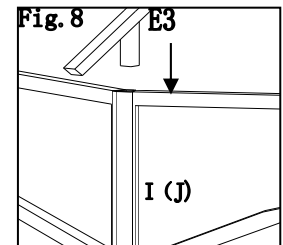
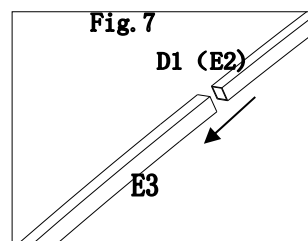
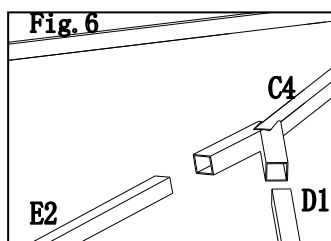
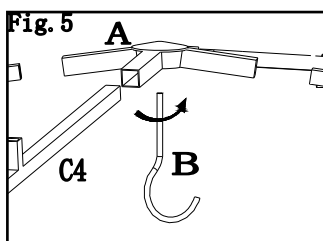
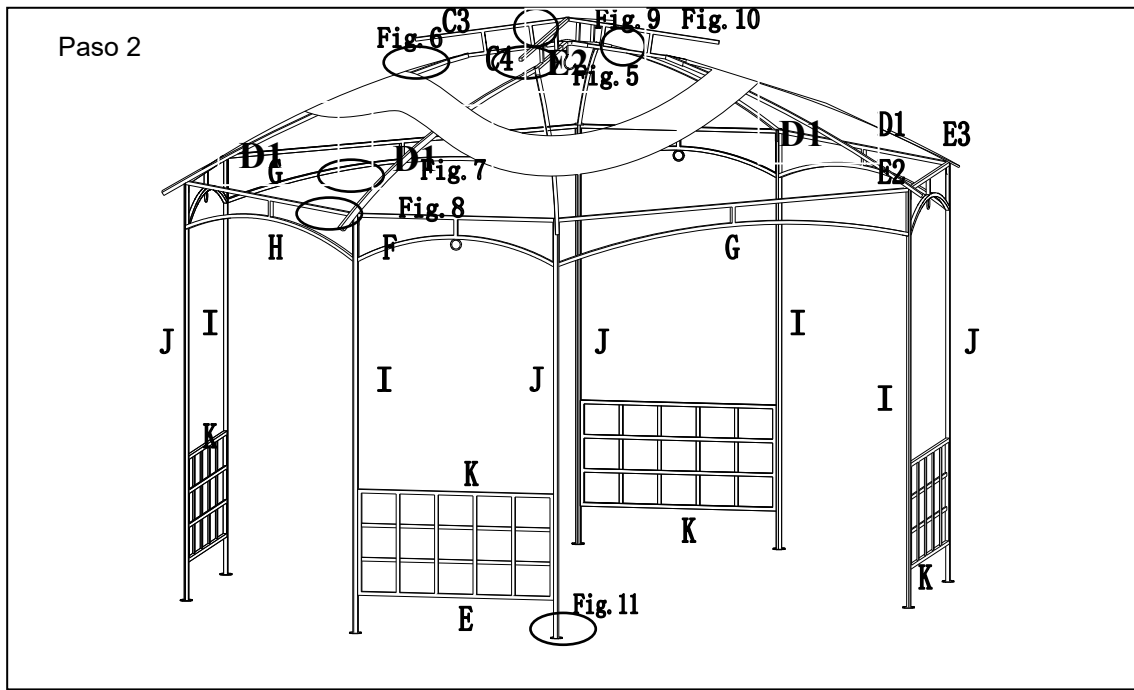

Fig.5: Introduzca la barrera (C4) en la conexión del techo 2 (A), y fije el gancho central (B) al conexión del techo 2 (A).

Fig.6: Introduzca la poste barra 1 (D1) a las poste barra 2 (E2) en la conexión 2 (C4).

Fig.7: Introduzca la poste barra 2 (E2) a las poste barra 1 (D1) en la conexión de esquina (E3)

Fig.8: Introduzca la conexión de esquinac (E3) en la poste 1 & 2 (I & J). Instale el toldo grande (M) sobre la estructura del techo (no la estire). Nota: la esquina más grande del conector grande (A) debe apuntar a la barra de arco más grande 3 (H).

Fig.9: Introduzca la conexión 1 (C3) en la conexión del techo 1 (A1). Instale completamente el toldo del techo (L) sobre la estructura del techo pequeño. Introduzca la finial (B1) en la conexión del techo 1 (A1)

Fig.10: Introduzca la conexión 1 (C3) en la conexión del conexión 2 (C4), completamente el toldo (M) y fijela a la extremidad de las conexiones de esquina (D).

Fig.11: Fije el quiosco a la tierra con las estacas (DD).

Lista de piezas de ferretería 3

FF	Anillo	60 PCS	
----	--------	--------	---

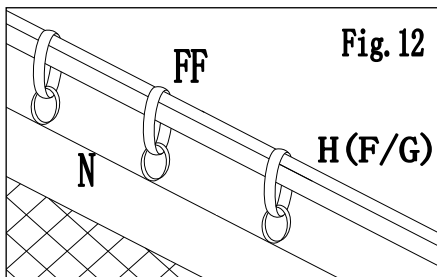
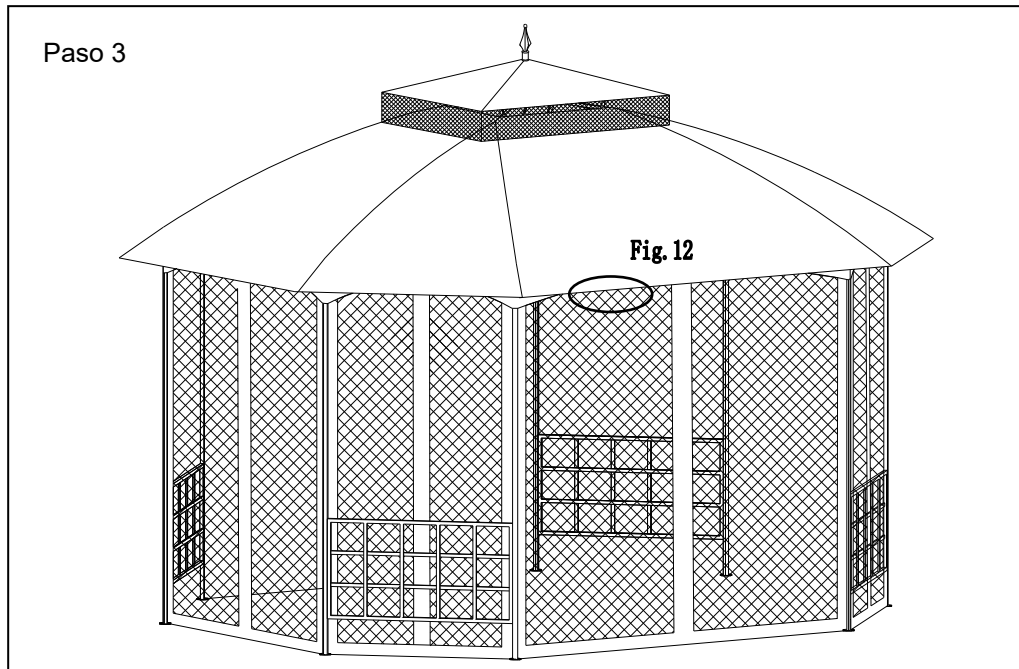

Fig.12: Colgar el mosquetero (N) en la barra de arco (H / F / G) con una atadura de plástico (EE).

GARANTÍA LIMITADA DE 1 AÑO:

Este product está garantizado por 1 año contra cualquier defecto de materiales y de mano de obra. Si está defectuoso, el product será reparado o reemplazado de forma gratuita. Basta con proporcionar el comprobante de compra y devolver a su lugar de compra. El desgaste normal o daños causados por mal uso o manejo, o reparaciones no autorizadas no están cubiertos. Esta garantía le otorga derechos legales específicos y usted puede tener otros derechos que varían de estado a estado.

Para obtener más información, comuníquese con nuestro departamento del servicio al diente, de telefono 1.866.578.6569, en horario de 8:30 a.m.a 8:30 p.m., hora estándar del este de EE.UU., de Lunes a Viernes o por correo electrónico a customer.care@sunjougroupp.com.

Fabricado para y distribuido por
la empresa True Value® Company
Chicago, IL 60631-3505
© 2019 True Value Company