

10x12' Domed Gazebo

TV. No: 243333

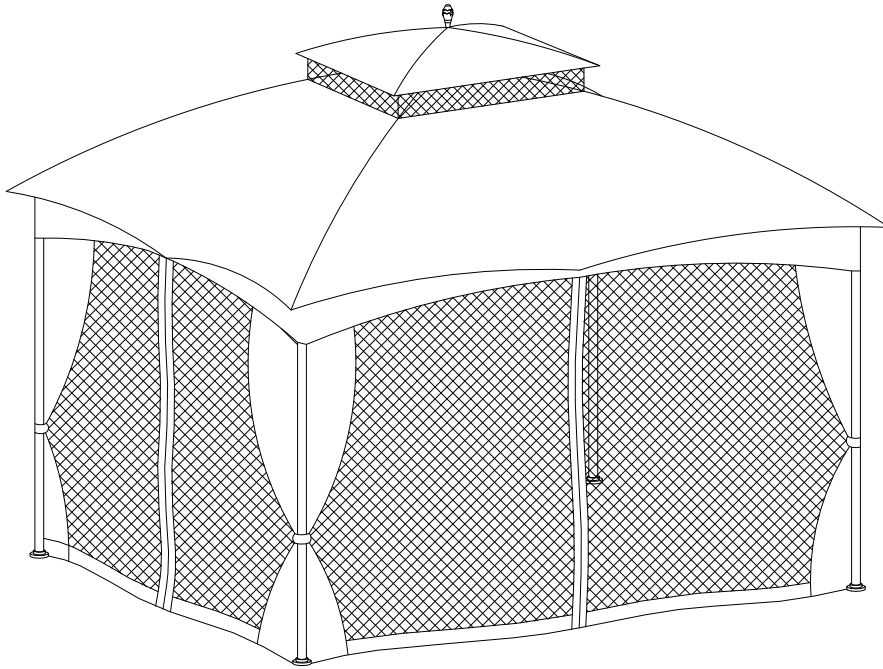

- Keep all children and pets away from assembly area. Children and pets should be supervised while gazebo is being assembled.
- The assembled gazebo should be located at least 6 feet (2 m) from any obstruction such as fence, garage, house, overhanging branches, laundry lines or electrical wires. Consult with local municipal office for specific requirements.
- This product is for domestic outdoor use i.e. decorative and sunshade purpose only.
- Install the gazebo on level ground. Stakes are provided to secure the gazebo to the ground. Do not assemble the gazebo on sandy, muddy or loose soil, as stakes do not have enough anchorage in these types of soil. If you wish to secure the gazebo to a wood deck or concrete surface, use anchors suited to these surfaces (anchors not included).
- Some parts may contain sharp edges. Wear protective gloves if necessary during assembly.
- This unit is heavy. DO NOT assemble this item alone. Make sure there is sufficient manpower for safe assembling or moving the gazebo.
- Check all nuts and bolts periodically for tightness and when required, tighten them again.
- While this gazebo is manufactured to withstand winds through only the supplied ground stakes, in areas subject to frequent severe weather, securing the gazebo to a deck, concrete patio or footings should be considered.
- Always ensure that the roof canvas is tensioned, so as to avoid water accumulation on the roof.
- Remove accumulated water on the roof immediately, or disassemble the gazebo in order to avoid damages.
- DO NOT remove snow from inside the gazebo by pushing on the fabric. Use a snow rake from the outside of the gazebo
- Snow must be cleared off regularly during snow day, remove the snow at the top when it is thicker than 4" (10cm). In order to avoid damages, use a plastic snow rake to remove excessive snow and ice buildup from roof and keep away from falling debris.
- ALWAYS DISASSEMBLE the gazebo before experiencing heavy wind conditions, as it is semi-permanent construction and not designed to withstand harsh weather, including high wind, rain and snow.
- Please check your state and local regulations prior to purchasing. Some jurisdictions may require permits for installation and use. Some special procedures may be valid in your area.

CAUTION:

- DO NOT use or enter the gazebo under harsh weather (e.g. thunderstorms, high winds, hail, heavy snow etc). In these conditions, it might tip over and could cause serious injury to bystanders. Any damage or injury caused by which is not covered by the warranty.
- DO NOT install the gazebo adjacent to trees or a sloped roof. Snow and ice may slide onto the gazebo and cause it to collapse.
- DO NOT use or enter the gazebo if there exist any of the following or of similar conditons:
 1. visible movement of support members, roofing panels or sagging roofline.
 2. creaks or audible noise from the gazebo.
 3. cracks, fractures or malformation of support member or roof panels.
 4. damaged or missing fasteners.
- DO NOT hang any weights on the roof frame.
- DO NOT use ladder leaning against the gazebo or climbing onto the roof.
- Keep away from heat or flame source.
- If the gazebo will not be used for a long period of time (e.g. during winter time), disassemble and store it in a clean, dry environment.











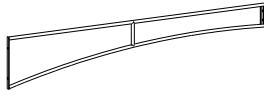
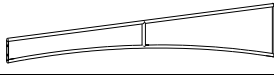
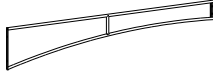
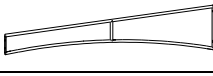

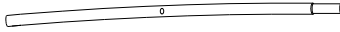
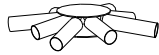

CARE AND MAINTENANCE:

- Our steel components for sun shelter and garden accessories are treated with rust inhibiting paint that protects it from rusting. However, due to the nature of steel, surface oxidation (rusting) will occur if these protective coatings are scratched. This is not a defect and thus not covered by the warranty.



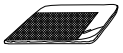

To minimize this condition, we recommend care when assembling & handling the product to prevent scratching the paint. Should any scratch or damage occurs, we recommend immediate touch-ups with rust inhibiting paint. Surface rust can also be easily removed with a very light application of regular cooking oil. If surface oxidation (rusting) occurs and if no measure is taken to prevent this, the oxidation may start dripping onto the deck or patio and caused damaging stains, which may be difficult to remove. This can be prevented if the above-mentioned measures are taken to keep the product from oxidizing.

- Do not use bleach, acid, or other abrasive cleaners on the roof or frame parts.
- Keep instruction manual for future reference.
- Keep the original packaging to store the sun shelter.

Part List

No.	Description	Qty	Image
A	Post	4	
B1	Long Left Screen	2	
B2	Long Right Screen	2	
C1	Short Left Screen	2	
C2	Short Right Screen	2	
D	Middle Board Connection	4	
E	Long Mosquito Netting Bar	4	
F	Short Mosquito Netting Bar	4	
G	Oblique Board	4	
H	Long Middle Board	2	
I	Short Middle Board	2	
J	Tube Under Oblique Board	4	
K	Big Roof Connection	1	
L	Small Roof Oblique Board	4	
M	Hook	1	
N	Small Roof Connection	1	
O	Decoration	1	
P	Small Canopy	1	
Q	Big Canopy	1	
R	Mosquito Netting	1	
S	Curtain	1	

Hardware Pack 1

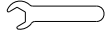
No.	Description	Qty	Image
AA	M6x20 Bolt	48 PCS	
BB	M6 Flat Washer	56 PCS	
DD	M6 Nut	8 PCS	
FF	M6 Spring washer	16 PCS	
Z	M6 Wrench	1 PC	

Step 1

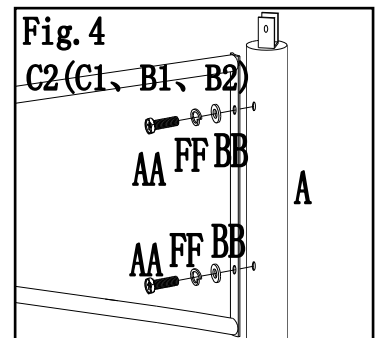
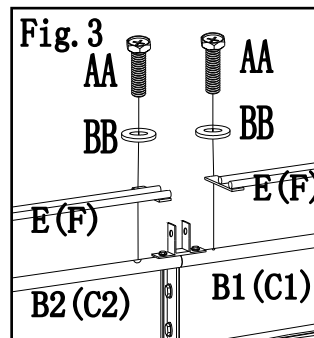
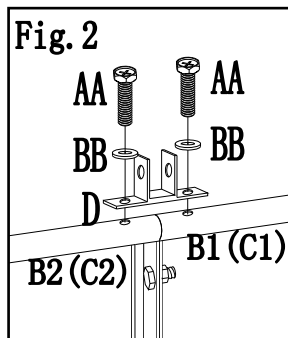
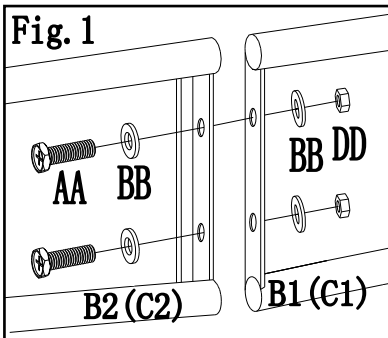
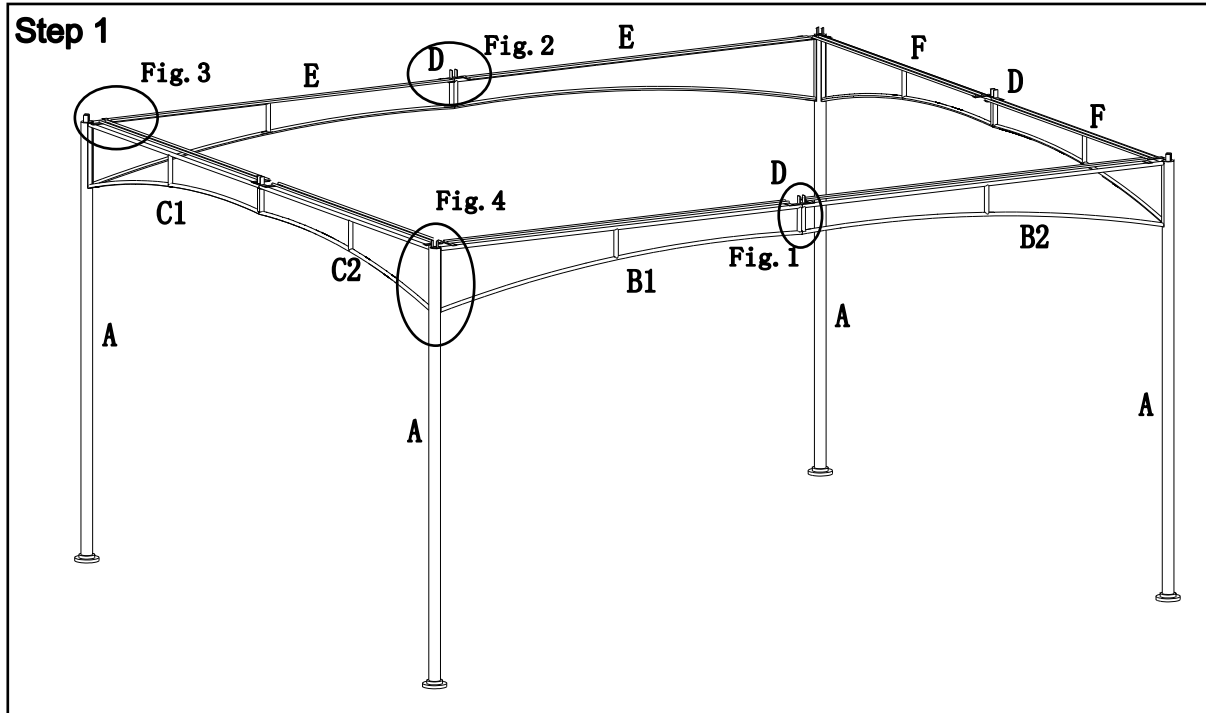





Fig.1: Connect the long screens (B1 and B2) and the short screens (C1 and C2) together using bolts (AA) and flat washers (BB). Securely tighten the connections and place nut (DD) over the bolts (AA).

Fig.2: Attach the middle board connections (D) to the screens (B1/B2 and C1/C2) using bolts (AA) and flat washers (BB).

Fig.3: Attach the long mosquito netting bars (E) to the long screens (B1 and B2) and the short mosquito netting bars (F) to the short screens (C1 and C2) using bolts (AA) and flat washers (BB).

Fig.4: Attach the screens (B1, B2, C1, C2) to the posts (A) using bolts (AA), spring washers (FF) and flat washers (BB). Please note the figure below to understand how the screens are attached to the posts with the mosquito bar facing the inside of the gazebo. Please see expanded view below.

Hardware Pack 2

No.	Description	Qty	Image
CC	M6x35 Bolt	8 PCS	
BB	M6 Flat washer	16 PCS	
DD	M6 Nut	8 PCS	

Step 2

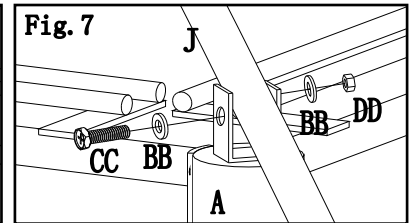
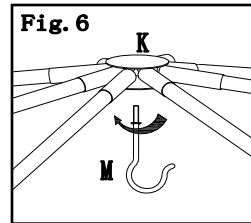
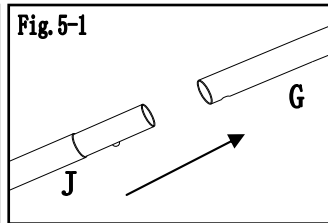
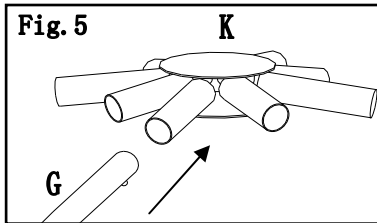
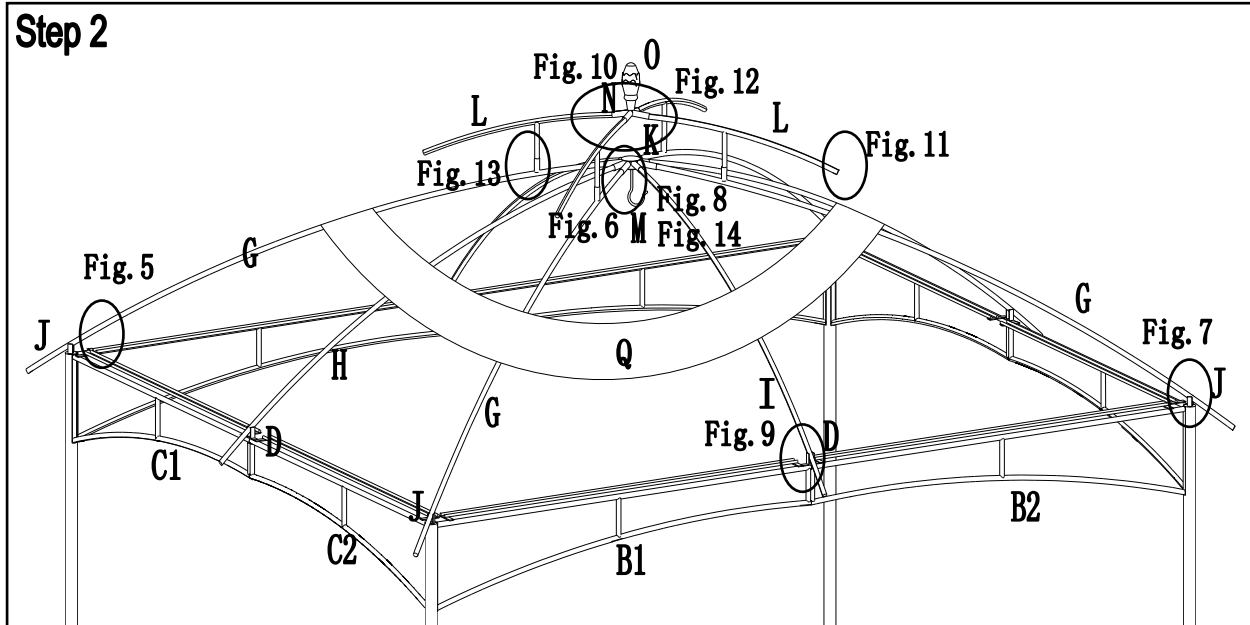

Fig.5 & Fig.5-1: Insert the oblique boards (G) to the big roof connection (K). Insert the tube under oblique boards (J) into the oblique boards (G).

Fig.6: Screw the hook (M) to the big roof connection (K).

Fig.7: Secure the tube under oblique boards (J) to the posts (A) using bolts (CC) and washers (BB). Tighten the connections and attach nut (DD) to the bolts (CC).

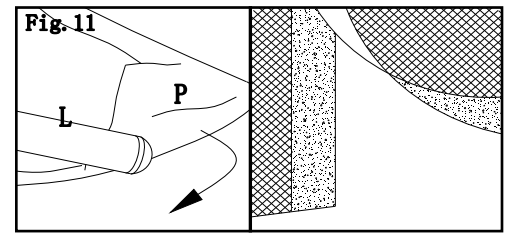
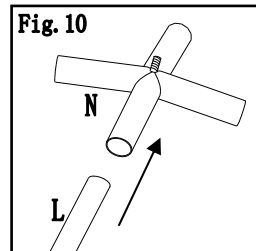
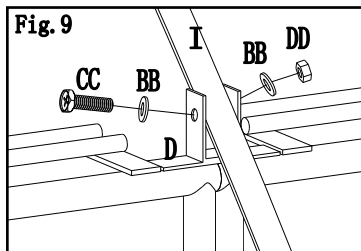
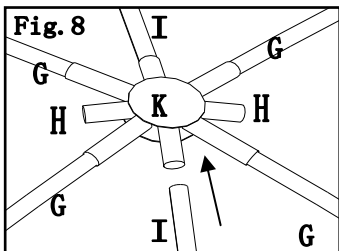

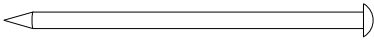

Fig.8: Insert the long/short middle boards (H/I) into the big roof connection (K)

Fig.9: Secure the middle boards (H and I) to the middle board connection (D) using bolts (CC) and flat washers (BB). Tighten securely and cover the bolts (CC) with nut (DD). Place the big canopy on top of the roof but do not unfold.

Fig.10: Attach the small roof oblique boards (L) into the small roof connection (N).

Fig.11: Attach the small canopy (P) along the small roof oblique board (L), aligning the corners and stretching it to fit.

Hardware Pack 3

No.	Description	Qty	Image
HH	Φ8x180 Stake	8 PCS	
GG	Mosquito netting ring	104 PCS	

Step 3

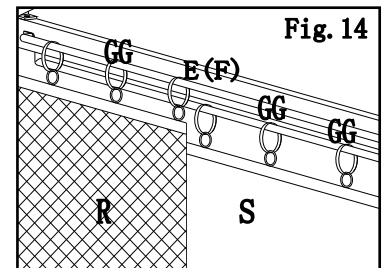
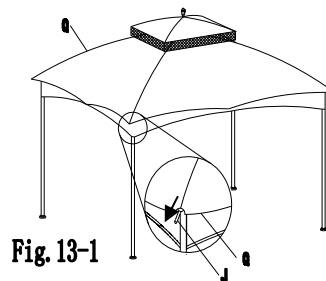
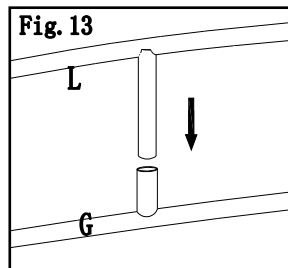
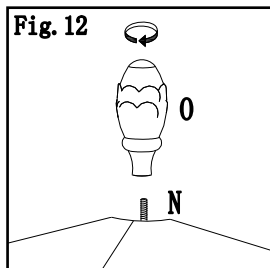
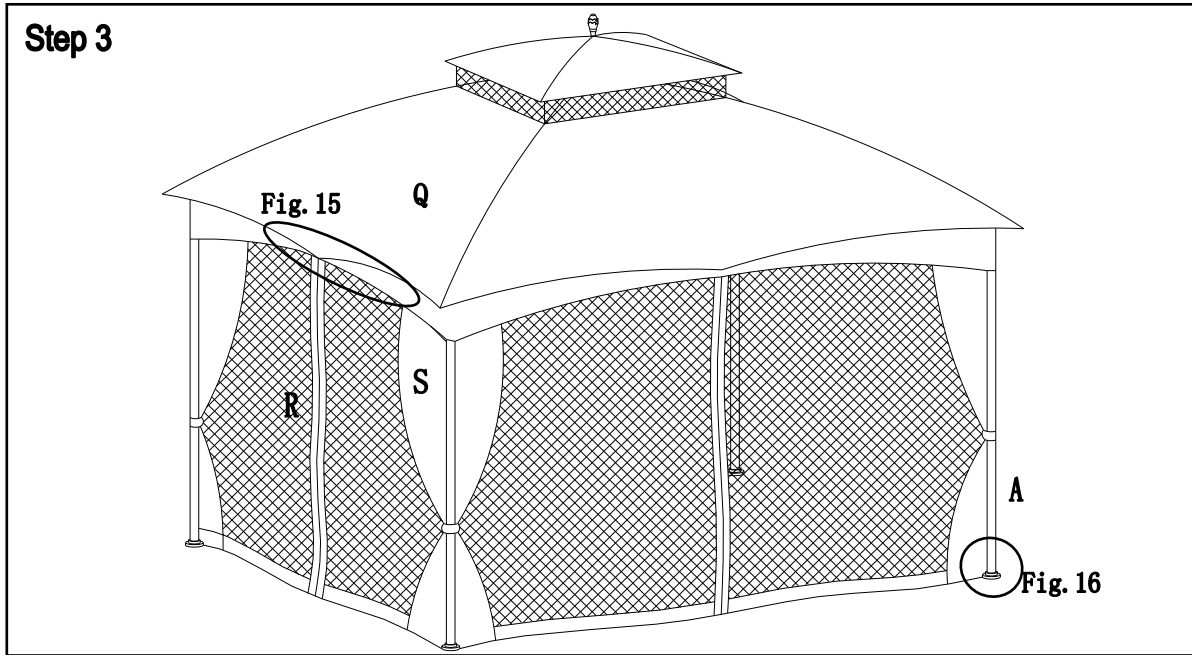

Fig.12: Screw the decoration (O) to the small roof connection (N).

Fig.13 & Fig.13-1: Insert the posts of the small roof assembly into the posts on the oblique boards (G) on top of the main roof assembly. Then, Spread the big canopy (Q), aligning the corners to the tube under oblique board (J).

Fig.14: Hang the mosquito netting (R) & curtains(S) on the mosquito netting bar (E & F) using mosquito netting rings (GG). Please note there is a long side and a short side to the netting. There will be 28 rings on the long side and 24 rings on the shorter side. Please note when properly assembled, make sure the curtains would be on the outside.

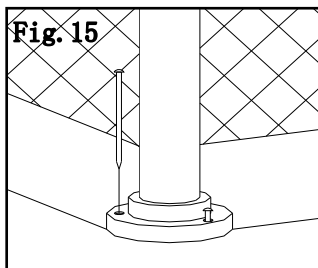

Fig.15: Secure assembled gazebo to the lawn with the Stakes (HH).

Please do not return this product to the store. For technical assistance on assembly or replacement parts call Sunjoy Group at 1(866) 578-6569 at any time or visit www.sunjoyonline.com to place your order