

IMPORTANT!! PLEASE READ ENTIRE INSTRUCTION SHEET BEFORE ASSEMBLY!!
TO EXPEDITE ANY FUTURE WARRANTY CLAIMS, PLEASE KEEP INSTRUCTION SHEET, WARRANTY CARD, AND RECEIPT









Step 1: Identify the parts packed in the carton against the parts list. Remove all protective materials and set the parts on a flat, non-abrasive surface.

** NOTE: PARTS SHOWN ON PARTS LIST ARE NOT TO SCALE*

Step 2: Attach the seat frame to the left leg by tightening the pre-assembled bolt in the back frame, then mount the back frame to the left leg as shown in **Figure 1**. Secure the leg to the seat frame by using the bolts and washers as shown in **Figure 2**. Guide the bolts through the holes in the seat frame, into the pre-drilled holes in the left leg. **Hand tighten only 2-3 turns**. Repeat this process(fig.1 & fig.2) for the right leg.

Step 3: After making any necessary adjustments to the alignment of the parts, use the hex bolt driver to tighten all bolts. **Do not over tighten**. Over tightening may strip bolts. Cover all bolts with covers.

Step 4: With the help of another person, turn the chair in the upright position. Your chair is now ready for use.

	<u>PARTS LIST</u>	<u>DESCRIPTION</u>	<u>ORDER PART #</u>	<u>QTY</u>
A		SEAT FRAME	SK1564	1
B		LEFT LEG	SK1565	1
C		RIGHT LEG	SK1566	1
D		1/4" X 35 MM BOLT	HW0142	4
E		Ø6.5 X 1.0 MM WASHER	HW0004	4
F		BOLT COVER	HW0105	4
G		HEX BOLT DRIVER	HW0006	1
		FOOT CAP FACTORY ASSEMBLY	FC0607	

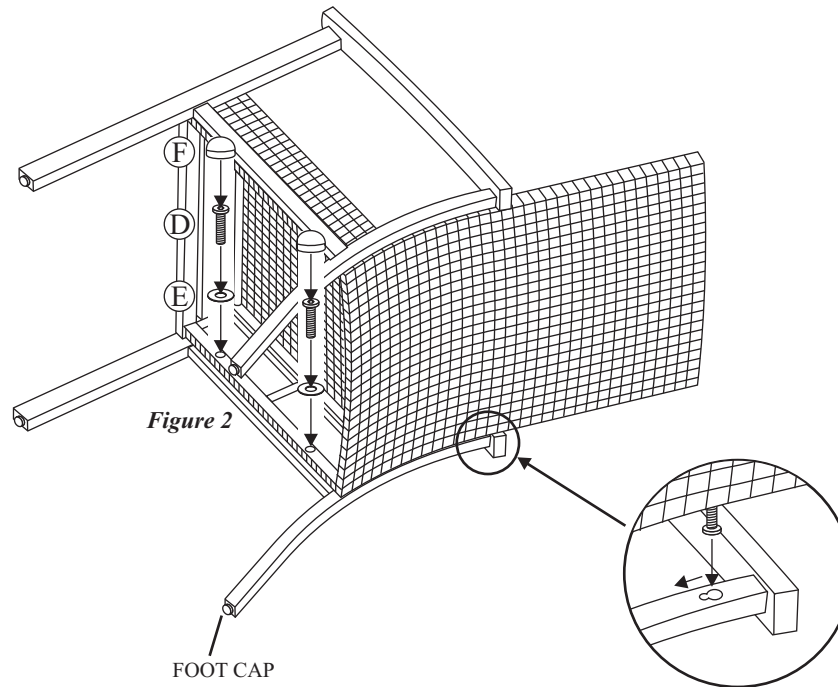
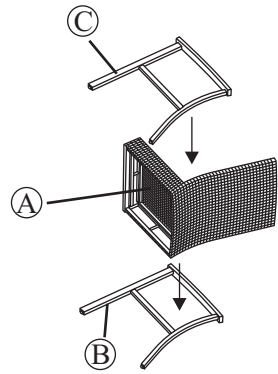

SKU #258732(B1T00400H60)

CARE AND MAINTENANCE

FRAMES

Cleaning - Use mild soap and warm water. Do not use abrasive materials, cleansers, or bleach products. Rinse with clean water and dry thoroughly.

Maintenance - Periodically clean and dry thoroughly. Be sure to drain any water accumulated inside the frames. To thoroughly drain frames, remove foot caps and tilt the frames, if necessary, to remove all water. This is critical. Water allowed to accumulate inside the frames and then exposed to sub-freezing temperatures can cause damage to the frame tubing. Such damage is not covered under warranty. Always clean, drain and dry thoroughly before storing for the winter. For best results, always store or cover your furniture when not in use. We recommend commercially available outdoor furniture covers. Any small nicks or scratches can be covered with a light application of touch-up paint.

** When cleaning or moving large or heavy items, always have two people work together. Never drag furniture.

FABRICS (CUSHIONS/SLINGS)

Cleaning - Wipe minor spills immediately. Clean with mild soap, warm clean water, and a soft cloth. Do not use abrasive materials, cleansers or bleach products. Although fabric has been treated to resist stains, occasional use of commercially available fabric cleaners may be necessary. Follow manufacturer's instructions.

Maintenance - The best way to maintain the beauty of cushions and slings is to store them in a dry area and out of the elements when not in use or cover with commercially available outdoor furniture covers.

STRAPS

Cleaning - Wash frequently with mild soap, warm water, and a soft cloth. Rinse thoroughly with warm, clean water. Do not use abrasive materials, cleansers, or bleach products.

Maintenance - Periodic application of commercially available vinyl cleaners and vinyl protectors will enhance the look and prolong the life of straps. If your strap chair has cushions, make sure any vinyl protectors applied are completely dry before placing cushion back on the chair.

1 YEAR LIMITED WARRANTY

This product is warranted for 1 year against any defects in material and workmanship. If defective, the product will be repaired or replaced free of charge. Simply provide proof of purchase and return the product to your place of purchase. Normal wear or damage due to abuse, mishandling, or unauthorized repairs is not covered. This warranty gives you specific legal rights and you may have other rights which vary from state to state.

LIMITED WARRANTY

- **Frames.** Frame construction is warranted against defects in material and workmanship for one year from purchase date. Damage to frames or welds resulting from improper assembly or exposure to water and/or sub-freezing temperatures is not covered.
- **Finishes.** Paint finishes are warranted against peeling, cracking and blistering for one year from purchase date provided the unit has not been scratched or abraded. Chips and scratches resulting from normal wear and tear are not covered.
- **Fabrics.** Fabric and cushions (if applicable) are warranted against separation at the seams for one year from purchase date. Fading and/or discoloration resulting from exposure to the elements, oils, spills, fluids, chemicals, or any other cause is not covered.
- **Straps and/or wicker.** Straps and/or wicker weave (if applicable) are warranted against separation and tearing for one year from purchase date. Fading and/or discoloration resulting from exposure to the elements, oils, spills, fluids, chemicals, or any other cause is not covered.
- **Umbrellas.** Umbrellas (if applicable) are warranted against defects in material and workmanship only for one year from purchase date. Umbrella bases (if applicable) are not covered under any circumstance.
- **Table tops.** Natural stone tabletops only are warranted against defects in materials or workmanship only for one year from purchase date. All other table tops (including without limitation glass and faux stone) are not covered under any circumstances.

Warranty limitations: This warranty is subject to the limitations set forth above. In addition, this warranty is made to the original purchaser only, and is effective only when item(s) is purchased from one of our authorized dealers. This warranty is not transferable. For warranty replacements based on warranty claims submitted within the first year of purchase, we will pay shipping and handling charges within the continental North America. After the first year, shipping and handling charges are your responsibility. We will not be responsible for charges associated with shipments outside the continental North America at any time or for any reason.

Warranty exclusions: This warranty is subject to the exclusions as set forth above. In addition, the following are excluded from coverage under this warranty: any item used for commercial, contract or any other non-residential purpose; clearance items, display models or items purchased "as is"; freight damage; items subject to misuse, abuse, neglect or lack of proper care and maintenance (including without limitation as provided in any "care and maintenance guide"); normal wear and tear; damage caused by acts of nature, acts of force majeure, vandalism, fire or other casualty, or improper assembly; hardware against corrosion or rusting; purchased or replacement parts; and all plastic parts. Also excluded are loss of use or time; inconvenience; money; travel; packaging; or incidental, special or consequential damages of any kind. Replacement of defective items as provided herein shall constitute your sole and exclusive remedy for items which are not as warranted. In no event shall our responsibility exceed the purchase price of the items found to be other than as warranted. This warranty is the exclusive statement of your rights with respect to the defects in the items you have purchased and supersedes any other express warranty or statement, written or oral, made in connection with the purchase and sale of such items. When used herein, the term "item" when used in the singular, refers to the specific item found to be defective, and not to the entire set of which the item is a part.

Some states do not allow exclusion or limitation of incidental or consequential damages, so that limitation above may not apply to you. This warranty gives you specific legal rights, and you may also have other rights which vary from state to state.



PATIO FURNITURE & ACCESSORIES ASSEMBLY INSTRUCTIONS

IMPORTANT!!!

STOP! PLEASE READ THESE INSTRUCTIONS CAREFULLY BEFORE ASSEMBLY. MAKE SURE YOU HAVE ALL THE PARTS AND HARDWARE AS IDENTIFIED ON THE PARTS LIST.

⚠WARNING: This product can expose you to chemicals including lead which is known to the State of California to cause cancer and birth defects or other reproductive harm. For more information go to www.P65Warnings.ca.gov

For customer service, please call 1-800-416-3511, Hours of Operation: Monday-Friday 9:00 am to 5:00 pm EST or email customerservice@va-cs.com.

Manufactured for and distributed
by True Value® Company
Chicago, IL 60631-3505
©2019 True Value Company

Four Seasons Courtyard®
is a trademark of the
True Value Company
Made in China