





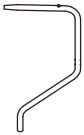

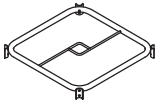

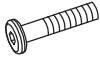

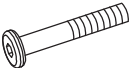
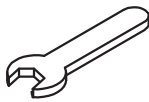

Table Assembly Instructions

TV. Item No: 259501

Model# HJ-1218

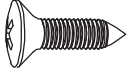

Assembly Parts List

A	Table Top		1PC	H	Nut(M6)		8PCS
B	Table Leg		4PCS	J	Bolt Cap(M6)		8PCS
C	Center Piece		1PC	K	Nut Cap(M6)		8PCS
D	Bolt (M6*38mm)	 M6*38	4PCS	AA	Wrench		1PCS
E	Bolt (M6*58mm)	 M6*58	4PCS	BB	Spanner		1PCS
F	Washer (M6)		8PCS	G	Bolt (Dia.4*16mm)		4PCS

Assembly Instructions

STEP 1:

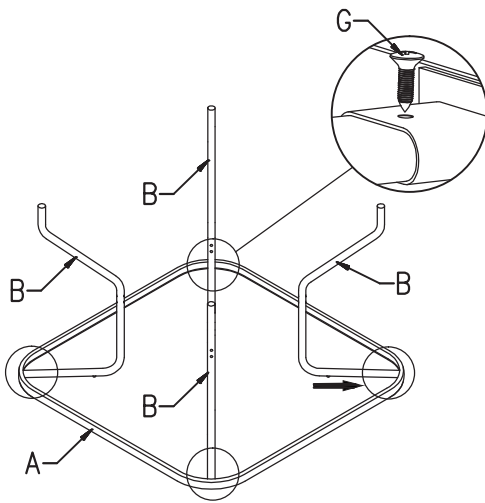

- Place table top(A)glass down on a soft surface such as carpet or blanket
- Place legs(B) into pre-installed plastic holders at each corner of the table as shown, using the bolt (G)

STEP 2:

- Attached center piece to legs using bolts(D & E),washers(F),nut(H)
- Note washer will go on the outside of bot the legs(B)and the center piece©
- Do not tighten until all 4 Legs are attached to the center piece
- Tightening with Wrench (AA & BB), Place nut cap(K) & bolt cap(J)

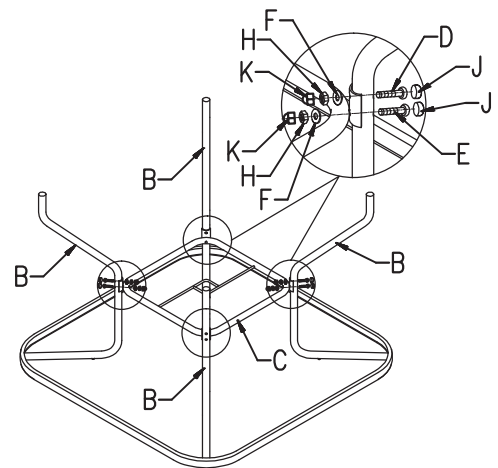

1 YEAR LIMITED WARRANTY

This product is warranted for 1 year against any defects in material and workmanship. If defective, the product will be repaired or replaced free of charge. Simply provide proof of purchase and return the product to your place of purchase. Normal wear or damage due to abuse, mishandling, or unauthorized repairs is not covered. This warranty gives you specific legal rights and you may have other rights which vary from state to state.

For customer service, please call 1(855)-294-1512, Hours of Operation: 24/7 or email customer service: service@rss-global.com.

Manufactured for and distributed
by True Value® Company
Chicago, IL 60631-3505
©2019 True Value Company

Fabricado para y distribuido por
la empresa True Value® Company
Chicago, IL 60631-3505
©2019 True Value Company

Four Seasons Courtyard®
is a trademark of the
True Value Company
Made in China

Four Seasons Courtyard®
es una marca comercial de
True Value Company
Hecho en China