



**Uptown 72"x 42" Boat Shaped Mesh Dining Table
1172-BXU
Assembly Instructions**

Parts List:

- | | |
|--------------------------|--------------------------|
| A. 1 Table Top | F. 20 Washers |
| B. 4 Legs | G. 4 Nuts |
| C. 2 Support bars | H. 20 Bolt Covers |
| D. 1 Bracket | I. 1 Hex Wrench |
| E. 16 Bolts | J. 1 Hex Wrench |







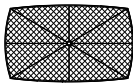

Step 1: Remove all protective packing materials and assemble all parts on a flat surface.

Step 2: Identify all parts packed in carton against attached parts list.

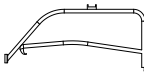
Step 3: Assemble all of the following parts together as shown in picture below: Table Top(A), Leg(B), Support Bars(C) etc.. If needed, turn furniture upside down to facilitate assembly. Make sure all parts are aligned properly before tightening any bolts and nuts.

Step 4: Tighten any bolts and nuts by using hex wrench (J) included in parts bag. Cover bolts with bolt covers and nuts with nut covers. Be sure bolts and nuts are tightened securely and aligned. It is user's responsibility to make sure all parts are assembled and tightened correctly and securely.

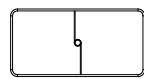
Diagram:

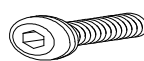
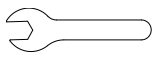
Ref	Part Name	Part Image	Qty	Ref	Part Name	Part Image	Qty
A	Table Top		1	F	Washers		20
B	Leg		4	G	Nuts		4
C	Support bars		1	H	Bolt Cover		20
D	Center Ring		1	I	Hex Wrench		1
E	Bolts		16	J	Hex Wrench		1

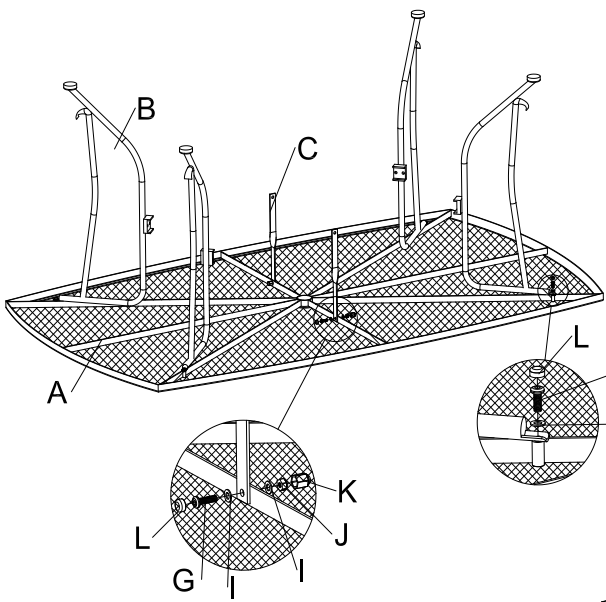

Photo 1

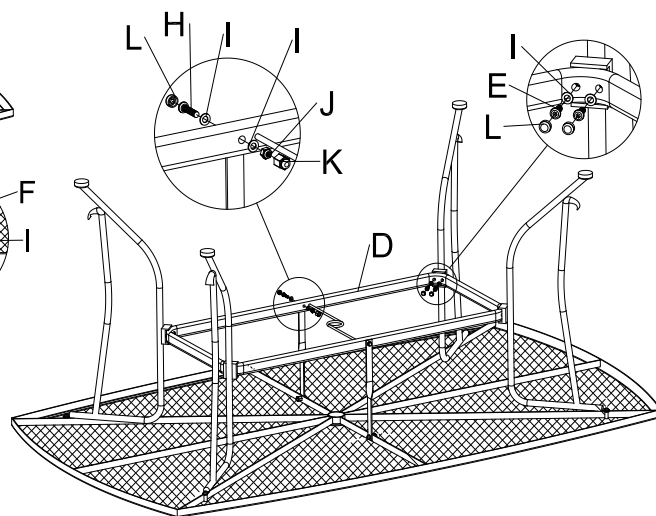

Photo 2

WOODARD
Customer Service Hours
8:00am-5:00pm CST Monday to Friday
Phone: (800) 877-2290 Fax: (800) 733-4257

PRINTED IN CHINA