



3PCS Newport Bistro Table RXTV-1806-SET-DT/227452 Assembly Instructions

Step 1: Remove protective wrapping first. Then lay all parts on floor and identify all parts packed in carton against attached parts list.

Step 2: Lay Table Top Frame (A) upside down on floor, so bottom is facing up. Place a protective soft material on floor before placing table top face down on floor.

Step 3: Then attach each of four legs (B) to the bottom, using Bolt (D) and Washer (E) and Bolt cover(F) as shown in Diagram 1, make sure leg in the 90 degree position first and then tighten the three bolts together for each leg.

Step 4: Make sure all bolts are aligned properly and tightened sufficiently. Then place bolt covers over bolts and turn the table over onto it's legs carefully using a flat surface and put Glass Top (C) on top (A) as shown in Diagram 2.

NOTE: IT IS USER'S RESPONSIBILITY TO MAKE SURE ALL PARTS ARE ASSEMBLED AND TIGHTENED PROPERLY AND SECURELY.

WARNING!: TABLE IS NOT MEANT FOR SITTING. DO NOT SIT OR LEAN FULL BODY AGAINST TABLE.

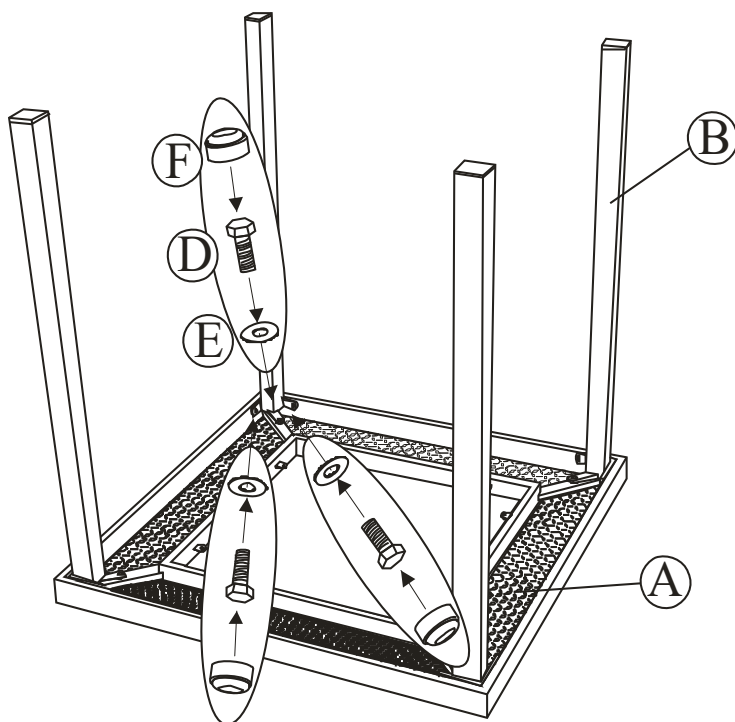

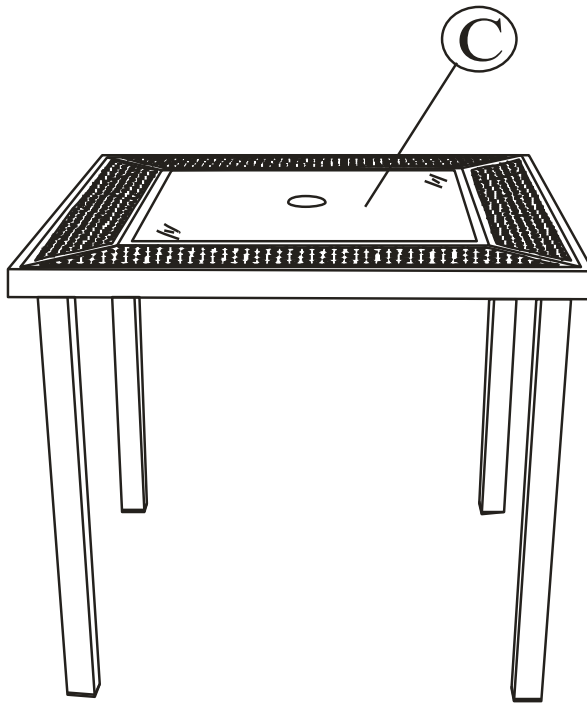



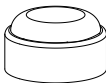
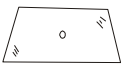
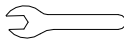
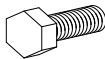

Diagram 2

PARTS LIST

Ref	Part Name	Part Image	Qty	Ref	Part Name	Part Image	Qty
A	Table Top Frame		1	E	Washer (M6)		12
B	Table Legs		4	F	Bolt Cover		12
C	Glass Top		1	G	Hex Wrench		1
D	Bolt		12				

WOODARD
Customer Service Hours
8:00am-5:00pm CST Monday to Friday
Phone: (800) 877-2290 Fax: (800) 733-4257