

SERRANOVA WOVEN SECTIONAL ARMLESS CHAIR

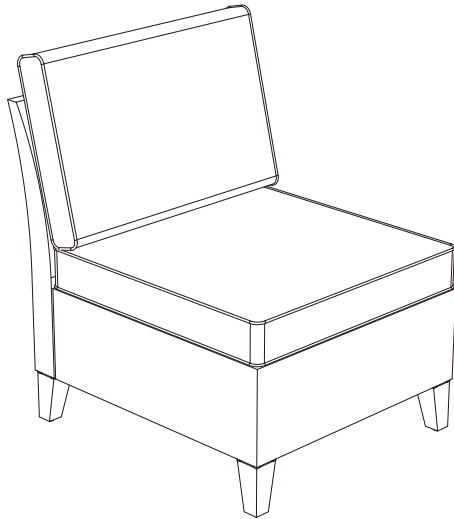

ASSEMBLY INSTRUCTIONS INSTRUCCIONES DE MONTAJE

Item Number: 258926 | Model Number: 501.0842.000



WARNING: This product can expose you to chemicals including lead which is known to the State of California to cause cancer and birth defects or other reproductive harm. For more information go to www.P65Warnings.ca.gov



ADVERTENCIA: Este producto puede exponerlo a sustancias químicas incluido el plomo, que, según la información que tiene el estado de California, provoca cáncer y malformaciones congénitas u otras consecuencias perjudiciales en el sistema reproductor. Para obtener más información, visite www.P65Warnings.ca.gov

Manufactured for and distributed by True Value® Company
Chicago, IL 60631-3505 ©2019 True Value Company

Fabricado para y distribuido por la empresa True Value® Company
Chicago, IL 60631-3505 ©2019 True Value Company

Four Seasons Courtyard® is a trademark of the True Value Company Made in China

Four Seasons Courtyard® es una marca comercial de True Value Company Hecho en China



READ & SAVE BELOW INSTRUCTIONS BEFORE ASSEMBLY



1. PLEASE SEPARATE AND IDENTIFY ALL PARTS, MAKING SURE THAT YOU HAVE ALL OF THE PARTS LISTED.
2. TO AVOID ANY SCRATCHES DURING ASSEMBLY, PLEASE ASSEMBLE ON A SOFT SURFACE.
3. PLEASE ASSEMBLE STEP BY STEP AND FOLLOW THE INSTRUCTIONS.
4. WASHERS MUST BE USED.
5. DO NOT OVERTIGHTEN BOLTS AND NUTS.
6. DO NOT COMPLETELY FASTEN EACH BOLT AND NUT UNTIL ALL THE BOLTS ARE PROPERLY ASSEMBLED.







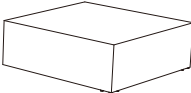

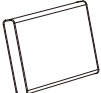
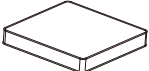

LEA Y GUARDE POR DEBAJO DE INSTRUCCIONES ANTES DE ASAMBLEA!

1. POR FAVOR SEPARAR E IDENTIFICAR TODAS LAS PIEZAS, ASEGURÁNDOSE DE QUE USTED TIENE TODAS LAS PIEZAS ENUMERADAS.
2. PARA EVITAR CUALQUIER ARAÑAZOS DURANTE EL ARMADO, POR FAVOR ARMAR SOBRE UNA SUPERFICIE BLANDA.
3. REALICE EL MONTAJE PASO A PASO Y SEGUIR LAS INSTRUCCIONES.
4. DEBEN USARSE LAVANDERAS.
5. NO APRIETE DEMASIADO LOS TORNILLOS Y LAS TUERCAS.
6. NO TOTALMENTE SUJETE CADA TORNILLO Y LA TUERCA HASTA QUE TODOS LOS TORNILLOS ESTÁN BIEN MONTADOS.

PARTS LIST/LISTA DE PIEZAS

CODE	PARTS	QTY.
A		1
B		1
C		4
D		1
E		1

HARDWARE LIST/LISTA DE HARDWARE

CODE	PARTS	QTY.
F		4
G		4
H		4
I		4
J		4
K		4
L		1
M		1

ASSEMBLY STEPS

! CAUTION: KEEP CUSHIONS AWAY FROM EXTREME HEAT OR OPEN FLAME! /
PRECAUCIÓN: MANTENER ALEJADO DE EXTREMO COJINES CALOR O DEL FUEGO!

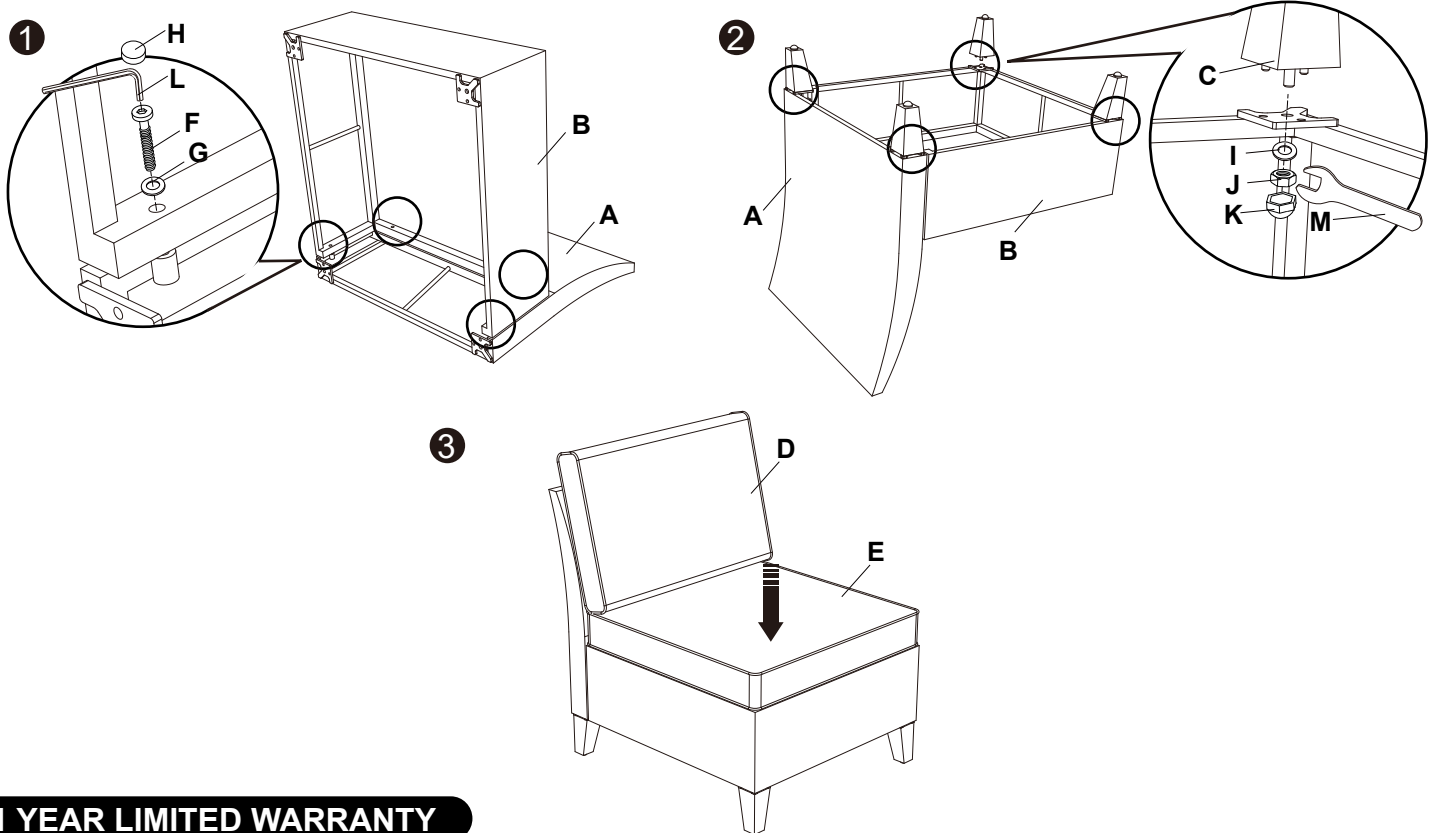

1 YEAR LIMITED WARRANTY

This product is warranted for 1 year against any defects in material and workmanship. If defective, the product will be repaired or replaced free of charge. Simply provide proof of purchase and return the product to your place of purchase. Normal wear or damage due to abuse, mishandling, or unauthorized repairs is not covered.

This warranty gives you specific legal rights and you may have other rights which vary from state to state.

For customer service, please call 855-259-5097, Hours of Operation: Monday-Friday 9:00am to 5:00 pm EST or email acs@americancustomerservice.com.

GARANTÍA LIMITADA DE 1 AÑO

Este producto está garantizado por 1 año contra cualquier defecto de materiales y de mano de obra. Si está defectuoso, el producto será reparado o reemplazado de forma gratuita. Basta con proporcionar el comprobante de compra y devolver a su lugar de compra. El desgaste normal o daños causados por mal uso o manejo, o reparaciones no autorizadas no están cubiertos. Esta garantía le otorga derechos legales específicos y usted puede tener otros derechos que varían de estado a estado.

Para servicio al cliente, llame al 855-259-5097, Horario de atención: de lunes a viernes de 9:00 a.m. a 5:00 p.m. EST o envíe un correo electrónico a acs@americancustomerservice.com.

CARE AND CLEANING:

1. TO CLEAN, WIPE WITH DAMP CLOTH. DO NOT USE BLEACH, ACID SOLVENTS OR ABRASIVE CLEANERS ON ARTIFICIAL WICKER OR FRAME PARTS.
2. DURING VARYING WEATHER CONDITIONS AND WINTER SEASON, WE STRONGLY RECOMMEND THAT THE FURNITURE BE STORED IN A DRY AREA WITH A SUITABLE COVER. BEFORE STORAGE, PLEASE INSURE THE FURNITURE IS CLEAN AND DRY.
3. IN THE EVENT OF BARE METAL SHOWING DUE TO SCRATCH, IT IS RECOMMENDED TO TREAT WITH A RUST REPELLING VARNISH OR SIMILAR PAINT
4. PERIODICALLY CHECK AND ENSURE THAT ALL THE SCREWS ARE COMPLETELY TIGHTENED.
5. A MATCHING FURNITURE COVER IS STRONGLY RECOMMENDED TO EXTEND THE LIFE OF YOUR FURNITURE.

CUIDADO Y LIMPIEZA:

1. PARA LIMPIAR, LIMPIE CON UN PAÑO HÚMEDO. NO UTILICE LEJÍA, ÁCIDOS, SOLVENTES O LIMPIADORES ABRASIVOS EN EL MIMBRE O EL MARCO ARTIFICIAL PIEZAS.
2. DURANTE DIVERSAS CONDICIONES METEOROLÓGICAS Y TEMPORADA DE INVIERNO, RECOMENDAMOS FIRMEMENTE QUE LA MUEBLES MANTENERSE EN UN ÁREA SECA CON UNA CUBIERTA ADECUADA. ANTES DE ALMACENAJE, POR FAVOR ASEGURAR QUE EL MUEBLE ESTÉ LIMPIA Y SECA.
3. EN CASO DE METAL DESNUDO QUE MUESTRA POR CERO, SE RECOMIENDA TRATAR CON UN ANTIOXIDANTE REPELER BARNIZ O PINTURA SIMILAR.
4. REVISE PERIÓDICAMENTE Y ASEGURARSE DE QUE TODOS LOS TORNILLOS ESTÉN BIEN APRETADOS.
5. A TAPA DE MUEBLES A JUEGO SE RECOMIENDA PARA EXTENDER LA VIDA DE SUS MUEBLES.

WARNING:

THE CHAIR WEIGHT CAPACITY IS 250 LBS.